

12	13	14	15
MAPX	MODIFICATION	DATE	APPROVE

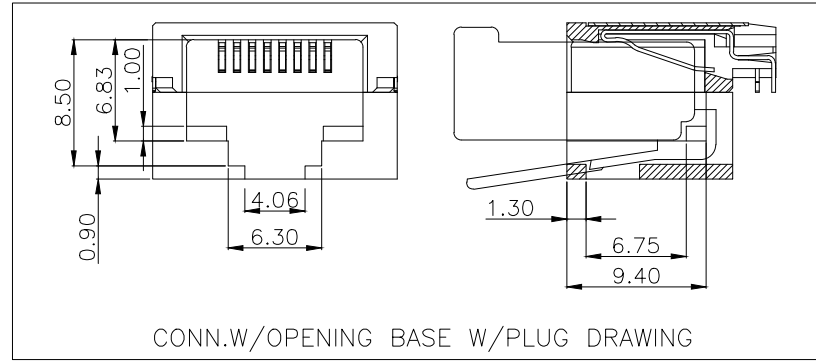
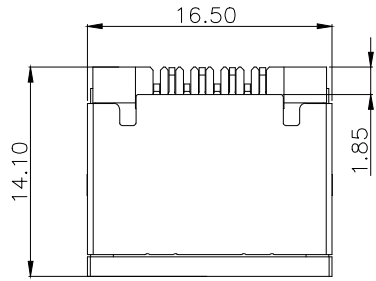

NOTES

MATERIAL

- 1.HOUSING: THERMO PLASTICS UL94V-0 BLACK.
- 2.CONTACT: PHOSPHOR BRONZE T=0.25mm.
- 3.PLATING: GOLD PLATING 1U" ON CONTACT AREA 50U" MIN NICKEL UNDERPLATING 60U" MIN TIN ON SOLDER TAIL NICKEL.
- 4.SHIELD: SUS T=0.20mm.WITH 30u" NICKEL PLATED.
- 5.LED: SPCC T=0.5mm.

ELECTRICAL

- 1.VOLTAGE RATING: 125 VAC RMS.
- 2.CURRENT RATING: 1.5 AMP.
- 3.CONTACT RESISTANCE: 40 MILLIOHMS MAX.
- 4.INSULATION RESISTANCE: 500 MEGOHMS MIN @ 100V DC .
5. DIELECTRIC DIELECTRIC RESISTANCE:500V DC RMS 50Hz. 1MIN.

MECHANICAL

1. DURRABILITY: 750 CYCLES MIN.
2. MATING/UNMATING FORC: 2.24 KG.F MAX.

ENVIRONMENTAL:

1. OPERATION: -40℃~+85℃.
2. STORAGE -40℃~+85℃.

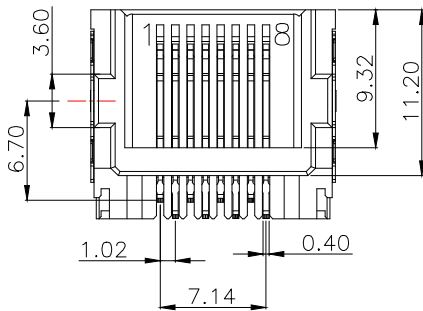
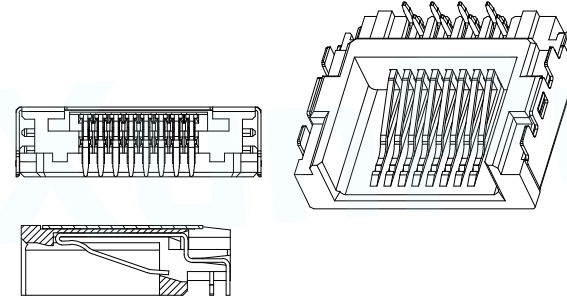
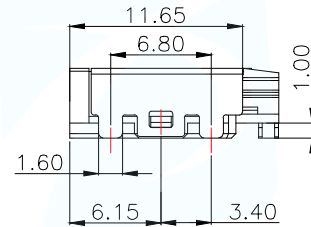
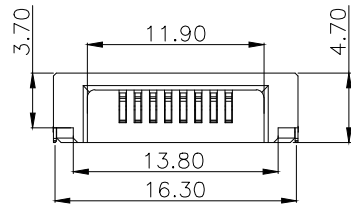

PART NUMBER DESCRIPTION:

RJ45-107-016-XX

- 电镀码
- 1-GOLD FLASH
- 流水码
- 1:PA9T黑 盘装
- 2:PA9T黑 卷装

8	—
7	—
6	RX-
5	—
4	—
3	RX+
2	TX-
1	TX+
PIN	说明

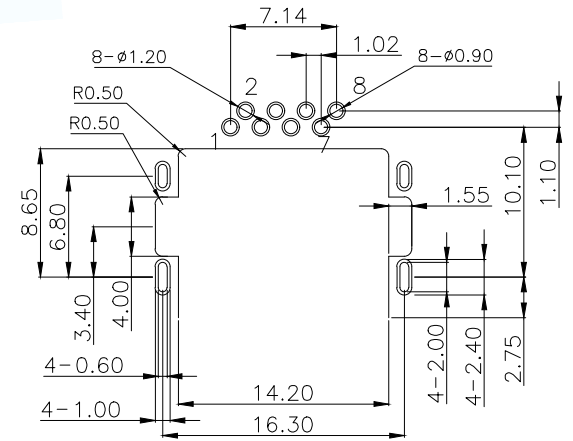

PBTLAYOUT

TOL:±0.05

MANUFACTURE DWG		东莞市讯普电子科技有限公司 DongGuan XunPu Electronics Co.,Ltd	
UNLESS OTHERWISE SPECIFIED TOLERANCES			TITLE: 半迪RJ45 沉板1.0 DIP 钢壳无灯
DECIMALS:	ANGLES:		PAR RJ45-107-016-11
.X:±0.35	X':±3'		DWN
.XX:±0.25	.X':±2'		CHKD
.XXX:±0.15	.XX':±1'	APVD	UNIT:MM
CUSTOMER COPY		SCALE:1:1	SIZE:A4
		UNIT:MM	SHEET:1F1
		REV:A	