

型号	CKT	A	B
WAFER-WTB4.2-02PZZ	2*1	0.00	5.40
WAFER-WTB4.2-04PZZ	2*2	4.20	9.60
WAFER-WTB4.2-06PZZ	2*3	8.40	13.80
WAFER-WTB4.2-08PZZ	2*4	12.60	18.00
WAFER-WTB4.2-10PZZ	2*5	16.80	22.20
WAFER-WTB4.2-12PZZ	2*6	21.00	26.40
WAFER-WTB4.2-14PZZ	2*7	25.20	30.60
WAFER-WTB4.2-16PZZ	2*8	29.40	34.80
WAFER-WTB4.2-18PZZ	2*9	33.40	39.00
WAFER-WTB4.2-20PZZ	2*10	37.80	43.20
WAFER-WTB4.2-22PZZ	2*11	42.00	47.40
WAFER-WTB4.2-24PZZ	2*12	46.20	51.60

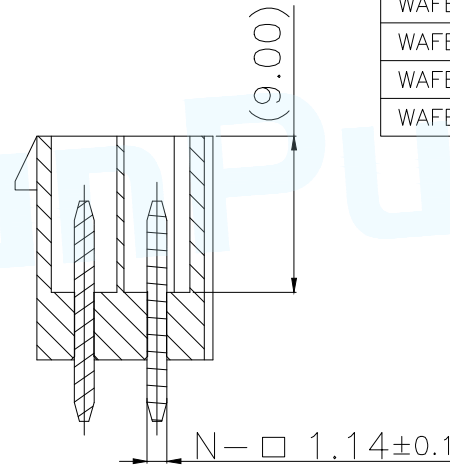

SECTION A-A
SCALE 1:1

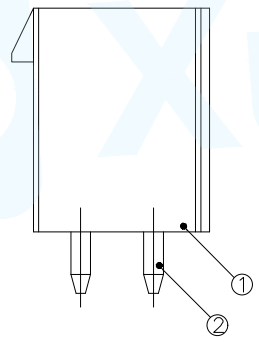
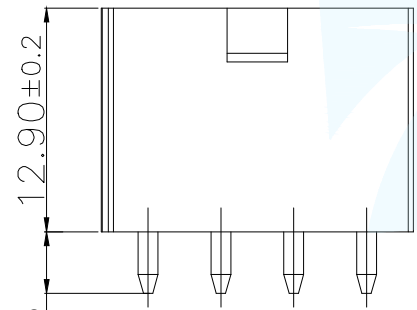
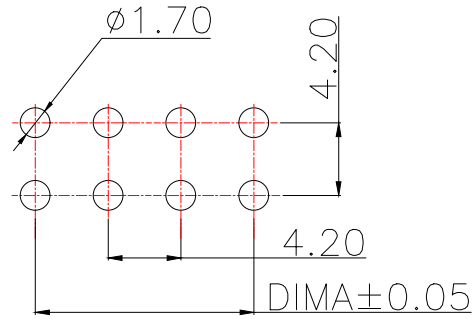

PCB.WELDING DRAWING (TOLERANCE:±0.05)

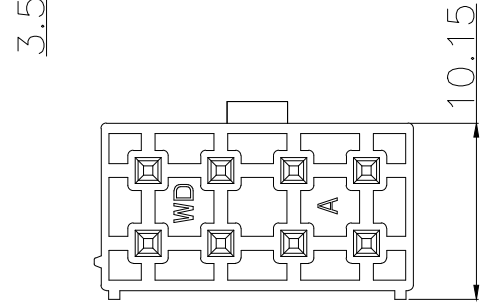

技术指标:

1. 温度范围: -25°C~85°C.
2. 额定电压: 250V AC,DC.
3. 耐电压: 1500V AC/minute.
4. 接触电阻: ≤20mΩ .
5. 绝缘电阻: ≥1000MΩ.
6. 额定电流: 5A AC,DC.

MANUFACTURE DWG		 东莞市讯普电子科技有限公司 DongGuan XunPu Electronics Co.,Ltd	
UNLESS OTHERWISE SPECIFIED TOLERANCES			TITLE: WTB4.2MM WAFER DIP TYPE
DECIMALS:	ANGLES:		PAR WAFER-WTB4.2-NPZZ
X.X±0.30	X.*±5°		DWN
X.XX±0.25	X.X*±1°		CHKD
X.XXX±0.15		APVD	SCALE:A UNIT:MM
CUSTOMER COPY		SIZE:A4	SHEET:1F1
			REV:A

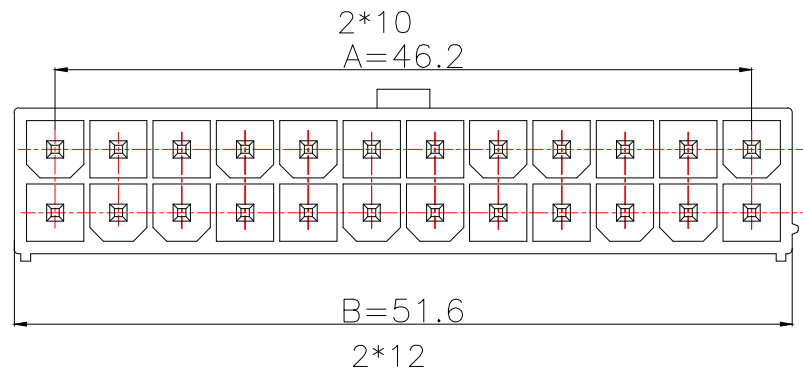
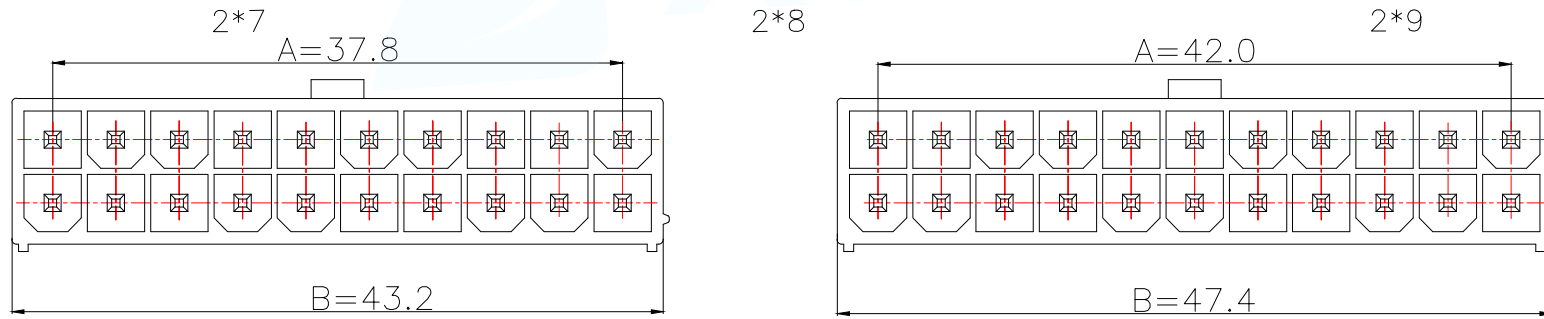
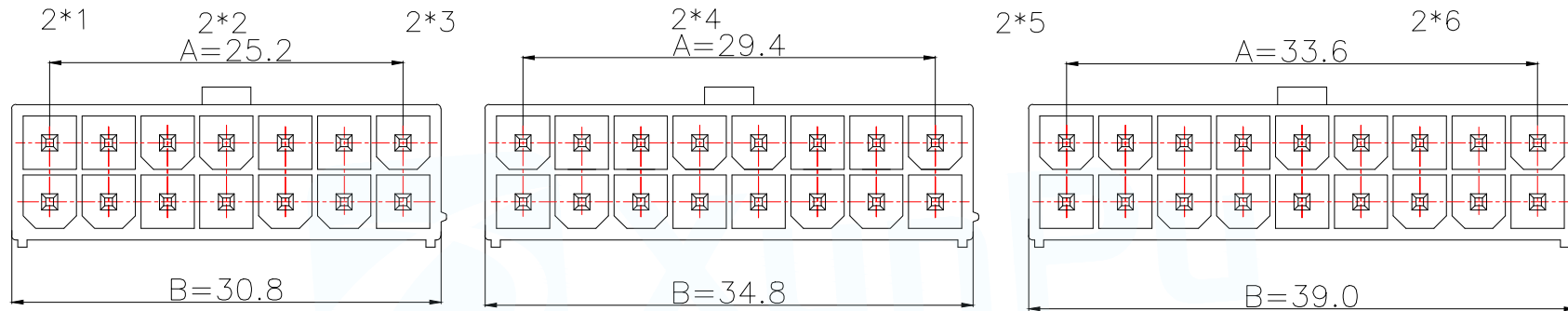
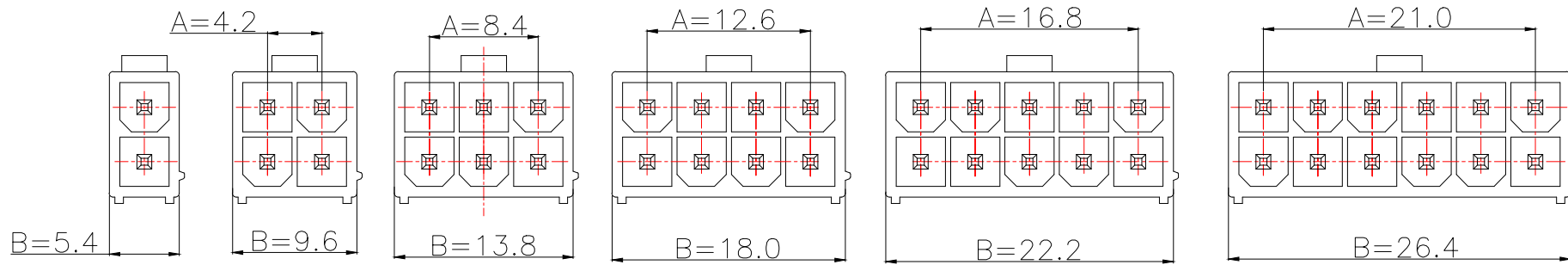

MANUFACTURE DWG		 东莞市讯普电子科技有限公司 DongGuan XunPu Electronics Co.,Ltd	
UNLESS OTHERWISE SPECIFIED TOLERANCES			TITLE: WTB4.2MM WAFER DIP TYPE
DECIMALS:	ANGLES:		PAR WAFER-WTB4.2-NPZZ
X.X±0.30	X.*±5°		DWN
X.XX±0.25	X.*±1°		CHKD
X.XXX±0.15		APVD	SCALE:A UNIT:MM
		CUSTOMER COPY	SIZE:A4 SHEET:1F1 REV:A