

MAPX	MODIFICATION	DATE	DRAW	APPROVE

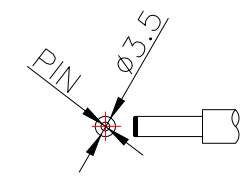

RECOMMEND PULG

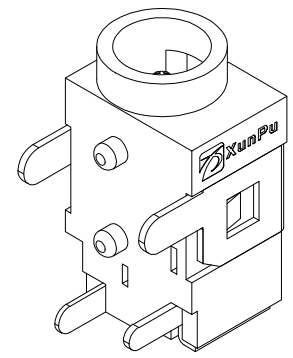
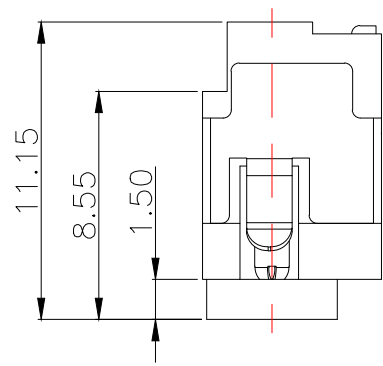
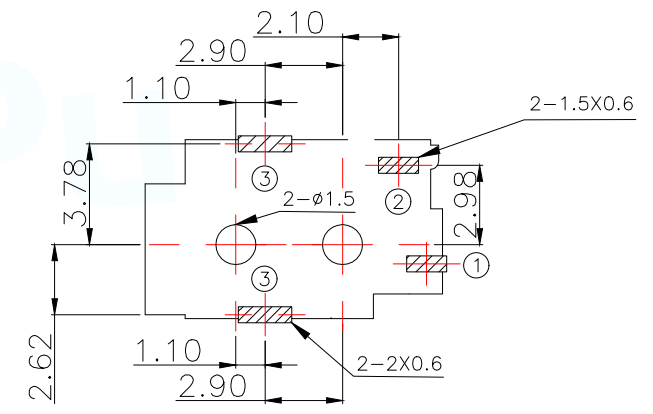
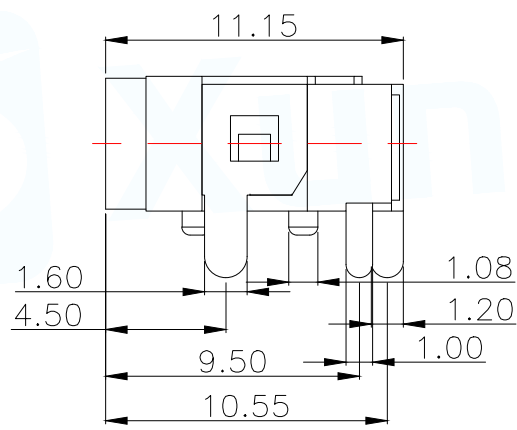
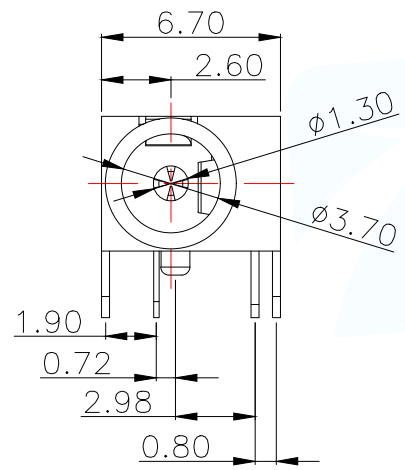

PCB.WELDING DRAWING (TOLERANCE:±0.05)

Main technical performance	
Rated electrical load	DC 12V 2A
Contact resistance	≤0.03Ω
Insulation resistance	≥100MΩ
Pressure resistance	AC 500V 1min
Insertion force	3-20N
Operating temperature range	-20C°~+70C°
service life	5000cycles

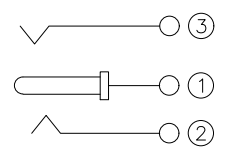

SCHEMATIC

3	HOUSING	1	PPA	BLACK
2	TIP SPRING	1	PHOSPHOR BRONZE	MB:CuSn PLATED
1	CENTER PIN	1	BRASS	MB:CuSn PLATED
LTR	PART NAME	QTY	MATERIAL	REMARK

MANUFACTURE DWG		东莞市讯普电子科技有限公司 DongGuan XunPu Electronics Co.,Ltd	
UNLESS OTHERWISE SPECIFIED TOLERANCES		TITLE: DC SOCKET	
DECIMALS:		PAR DC-031-A130	
ANGLES:		DWN	
X.X±0.30	X.*±5°	CHKD	
X.XX±0.25	X.X*±1°	APVD	
X.XXX±0.15		SCALE N:A	UNIT:MM
CUSTOMER COPY		SIZE:A4	SHEET:1F1
			REV:A