

MINI SIM CARD	
Pin No.	NAME
C1	VCC OF SIM
C2	RST OF SIM
C3	CLK OF SIM
C5	GND OF SIM
C6	VPP OF SIM
C7	I/O OF SIM
C4/C8	N/A

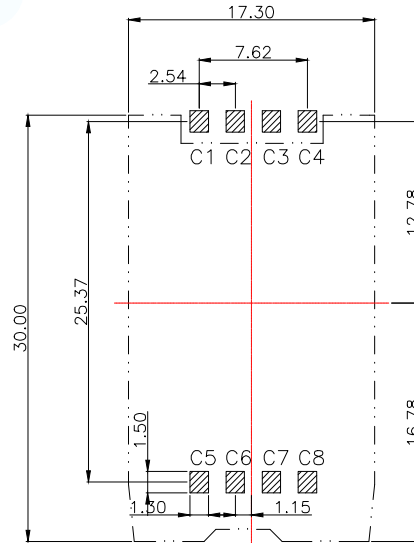

RECOMMENDED PCB LAYOUT  
GENERAL TOLERANCE ±0.05

Specification 规格:

Material 物料规格:

Housing 塑胶主体:LCP UL94V-0  
Contact Terminal 接触端子:Phosphor Bronze  
Metallic Shell 金属外壳:Stainless Steel-SUS304

Plating 电镀规格:

Contact Terminal Plating 接触端子部分电镀  
Contact Area:5μ” Gold  
Soldering Area:100μ” Tin  
Under-plating:50μ” Nickel above

Electrical 电气规格:

Voltage Rating 电压额定值:50 V max  
Current Rating 电流额定值:1A max  
Operating Temperature 工作温度:-40°C to +85°C  
Contact Resistance 接触电阻值:50 mΩ typical,100mΩ max  
Insulating Resistance 绝缘电阻值:1000 MΩ min.(Apply施加500V DC)  
Dielectric Withstanding Voltage 耐电压:500 VAC for 1 minute

Mechanical 机械性规格:

Durability 耐久性:min 5,000 cycles

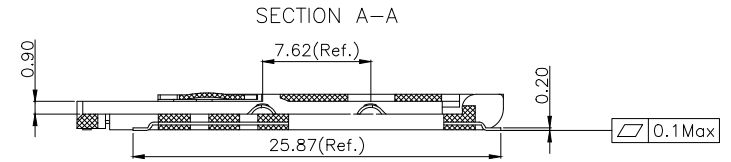

MANUFACTURE DWG		东莞市讯普电子科技有限公司 DongGuan XunPu Electronics Co.,Ltd	
UNLESS OTHERWISE SPECIFIED TOLERANCES			TITLE:Mini sim card 8pin 翻盖式
DECIMALS:	ANGLES:		PAR SIM-105-ARP8
X.:±0.20	X':±2'		DWN
X.X:±0.15	X.X':±1'		CHKD
X.XX:±0.10	X.XX':±0.5'	COPY: A4	APVD
CUSTOMER		SCALE:1:1	UNIT:MM
		SHEET:1F1	REV:A

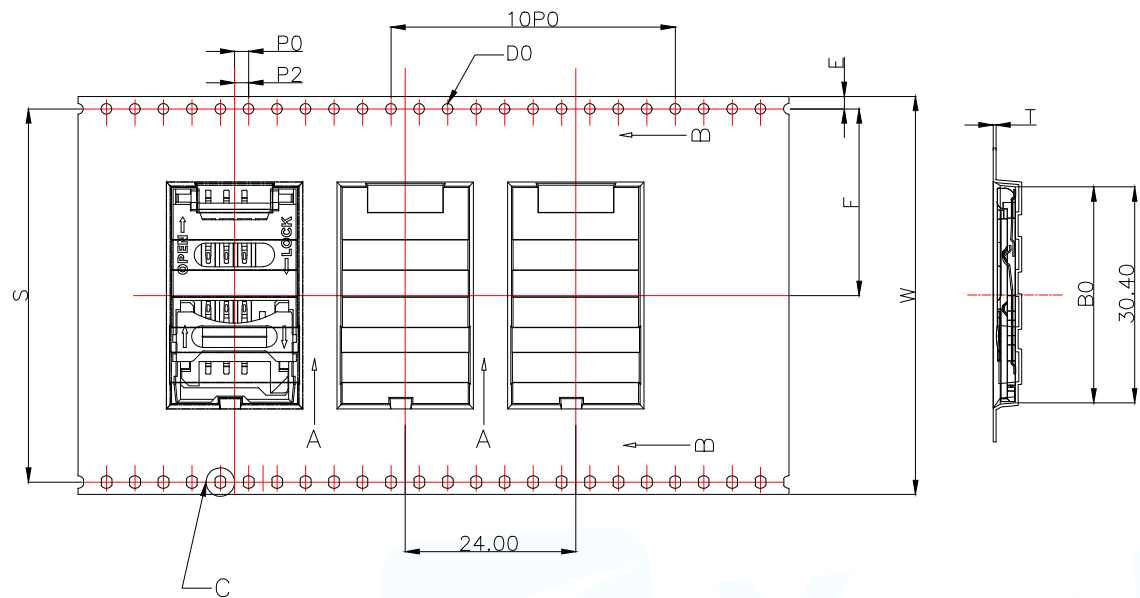

卷装示意图仅供参考

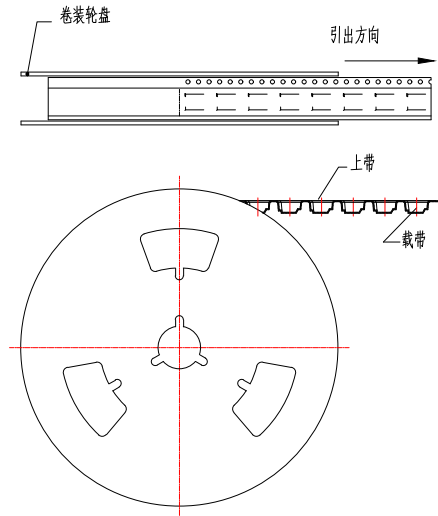

330X100X56

尺寸栏	
E	1.75±0.10
S	52.50±0.15
F	26.25±0.15
P2	2.00±0.10
∅D <sub>o</sub>	1.50 <sup>+0.10</sup> <sub>-0.00</sub>
∅D <sub>1</sub>	
P <sub>o</sub>	4.00±0.10
10P <sub>0</sub>	40.00±0.20
W	56.00±0.30
P	24.00±0.10
A <sub>o</sub>	17.70±0.10
B <sub>0</sub>	30.40±0.10
K <sub>0</sub>	3.60±0.10
T	0.35±0.05

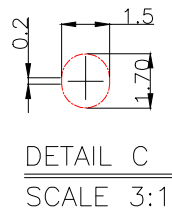
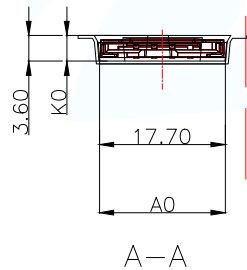

生产参数	
模数	180模
颗数	710颗
卷轮	13"/56
包装数	700颗

- 说明:
- 10个边孔的累计公差不能超过±A<sub>0</sub>.2mm.
  - 材料规格:黑色 PS,厚度0.40mm.
  - 1.13英寸卷轮卷装长度:17.28米。(零件包装长度:16.80米)。
  - 1.13寸卷轮包装零件总颗数:710颗。(实际包装零件颗数:700颗)。

5. 所有尺寸设计参照EIA-481-C-2003.
6. 载带在250mm长度以内最大弯曲度不超过1mm(见下图)。

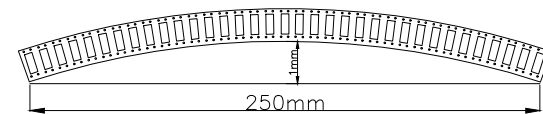

MANUFACTURE DWG		东莞市讯普电子科技有限公司 DongGuan XunPu Electronics Co.,Ltd	
UNLESS OTHERWISE SPECIFIED TOLERANCES			TITLE:Mini sim card 8pin 翻盖式 包装图
DECIMALS:	ANGLES:		PAR SIM-105-ARP8
X.:±0.50	X.':±5°		DWN
X.X:±0.25	X.X':±3°		CHKD
X.XX:±0.12	X.XX':±1°	APVD	SCALE 1:1 UNIT:MM
CUSTOMER COPY		SIZE:A4	SHEET:1F1
			REV:A