

12	13	14	15
MAPX	MODIFICATION	DATE	APPROVE

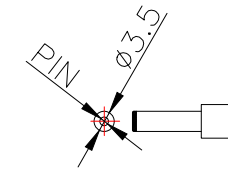

RECOMMEND PULG

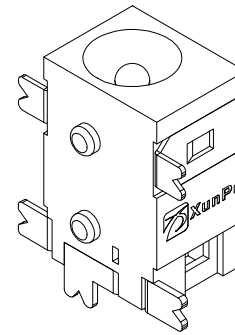
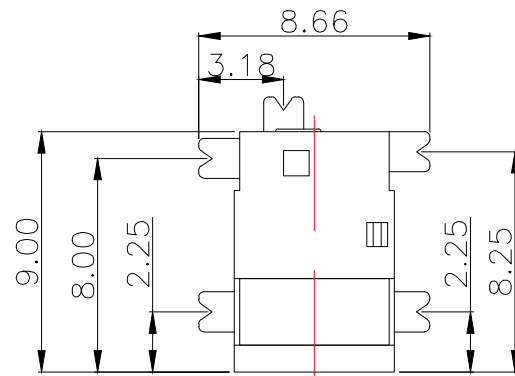
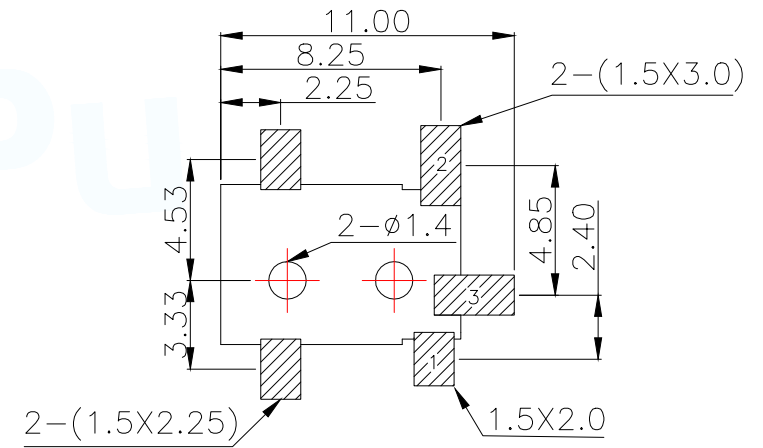
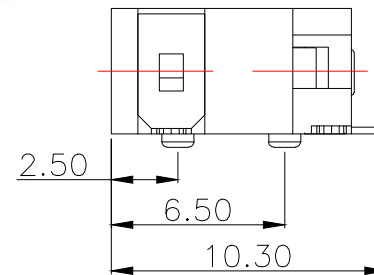
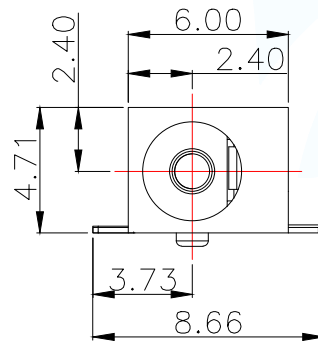

PCB.WELDING DRAWING (TOLERANCE:±0.05)

Main technical performance	
Rated electrical load	DC 12V 2A
Contact resistance	≤0.03Ω
Insulation resistance	≥100MΩ DC250V
Pressure resistance	AC 500V 1min
Insertion force	3-30N
Operating temperature range	-20C°~+70C°
service life	5000cycles

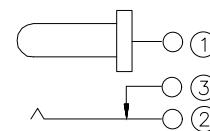

SCHEMATIC

3	HOUSING	1	PPA	BLACK
2	TIP SPRING	1	PHOSPHOR BRONZE	MB:CuSn PLATED
1	CENTER PIN	1	BRASS	MB:CuSn PLATED
LTR	PART NAME	QTY	MATERIAL	REMARK

MANUFACTURE DWG		 东莞市讯普电子科技有限公司 DongGuan XunPu Electronics Co.,Ltd	
UNLESS OTHERWISE SPECIFIED TOLERANCES		TITLE: DC SOCKET	
DECIMALS: X.X±0.30			PAR DC-092-A130
ANGLES: X.*±5°			DWN
X.XX±0.25			CHKD
X.XXX±0.15			APVD
CUSTOMER COPY		SCALE N:A	UNIT:MM
		SIZE:A4	SHEET:1F1
			REV:A